

PMM

- ALZACRISTALLI PER VEICOLI INDUSTRIALI
- WINDOW REGULATORS FOR TRUCKS
- FENSTERHEBER ZUM LASTWAGEN U
- LEVE-VITRES POUR VÉHICULES INDUSTRIELS
- ELEVACIONES PARA VEHÍCULOS INDUSTRIALES

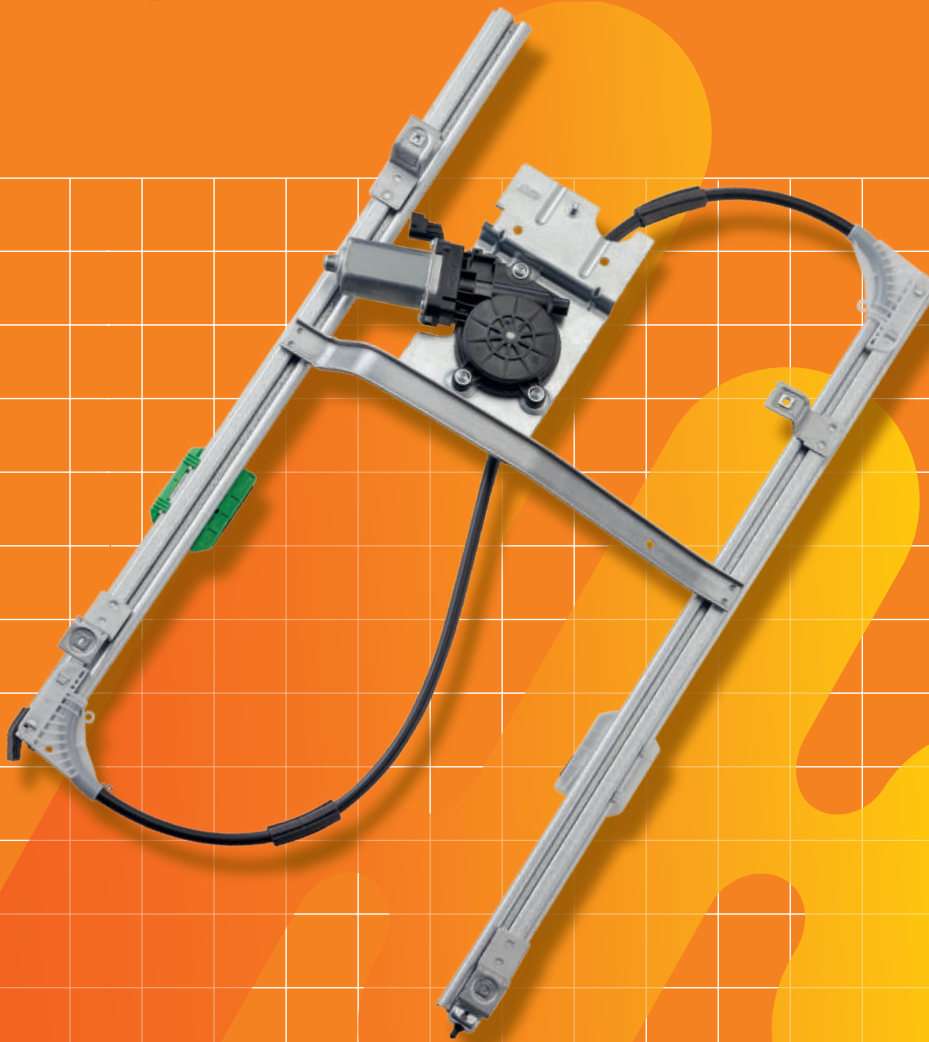



ALGO GROUP

ALGO Group, con **oltre 40 anni di esperienza**, è l'azienda leader nello sviluppo e nella produzione di alzacristalli e maniglie.

Il gruppo nasce da un'intensa attività di produzione per il primo equipaggiamento (Original Equipment -OE) dedicata alla realizzazione di articoli per i principali costruttori di automobili. Attualmente il core business del gruppo è soprattutto l'Aftermarket, sebbene il 25% della produzione globale rimane quella di primo equipaggiamento, dove il gruppo è universalmente apprezzato per la **qualità**, la **professionalità** e la **flessibilità** nella **progettazione** e nello **sviluppo**.

Il mantenimento di un elevato livello qualitativo ha permesso al gruppo di ottenere le **certificazioni ISO 9001:2008 e ISO/TS 16949 di primo equipaggiamento (OE)**.

La sede commerciale globale di ALGO Group si trova ad Albavilla ed è affiancata da tre stabilimenti produttivi e da un centro logistico in **Italia**, da uno stabilimento produttivo in **Polonia** e dalla sede NAFTA di **Città del Messico**.

*With **more than 40 years' experience**, the ALGO Group is the aftermarket's leader for the development and production of power windows and door handles.*

ALGO originally started off as an OE manufacturer, supplying all major car makers.

*Nowadays, although ALGO's core business is the aftermarket, the involvement with the OE production still remains in the percentage of up to 25%, which is highly appreciated for its **quality, proficiency and flexibility** in **design** and **development**.*

*As the high quality level is one of ALGO's main priorities, the company obtained the **ISO 9001:2008 and ISO/TS 16949 certifications for the OE production**.*

*ALGO's headquarters is based in Albavilla, Como, **Italy**, with three production plants also in Italy, one in **Poland** and one facility in **Mexico**.*

 LIFT TEK

 ELECTRIC-LIFE

 PMM

 MIRAGLIO

DOPPIA FUNE GUIDATA | *DOUBLE BOWDEN TYPE* MECCANISMO | *MECHANICAL PART ONLY*

- 1** GUIDA
RAIL
- 2** FUNE
CABLE
- 3** PATTINO / PIASTRA DI SOLLEVAMENTO
SLIDING GLASS FIXATION PLATE
- 4** CARTELLA FISSAGGIO MOTORIDUTTORE
MOTOR FIXATION PLATE
- 5** STAFFA PORTACARRUCOLA
ROLLER BRACKET
- 6** STAFFA DI FISSAGGIO
FIXATION BRACKET
- 7** TAMBURO
DRUM
- 8** GOMITO IN PLASTICA
PLASTIC ELBOW

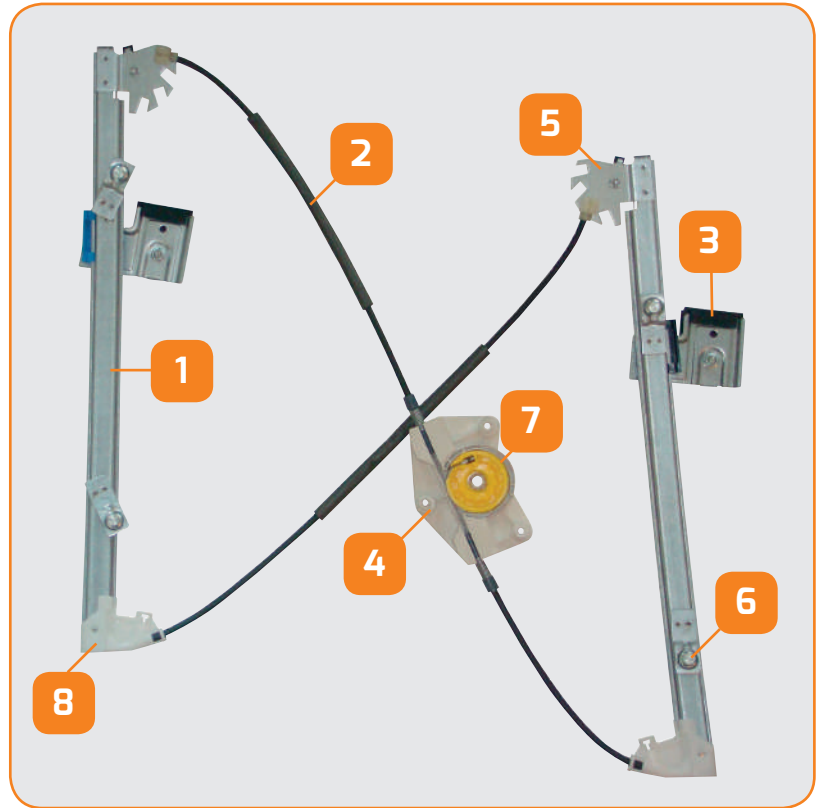

FUNE GUIDATA | *BOWDEN TYPE* ALZACRISTALLO COMPLETO | *WINDOW LIFTER WITH MOTOR*

- 1** GUIDA
RAIL
- 2** FUNE
CABLE
- 3** PATTINO / PIASTRA DI SOLLEVAMENTO
SLIDING GLASS FIXATION PLATE
- 4** CARTELLA FISSAGGIO MOTORIDUTTORE
MOTOR FIXATION PLATE
- 5** STAFFA PORTACARRUCOLA
ROLLER BRACKET
- 6** STAFFA DI FISSAGGIO
FIXATION BRACKET
- 7** CONNETTORE
CONNECTOR
- 8** CENTRALINA
ELECTRONIC BOX
- 9** MOTORIDUTTORE
MOTOR
- 10** CARRUCOLA
ROLLER

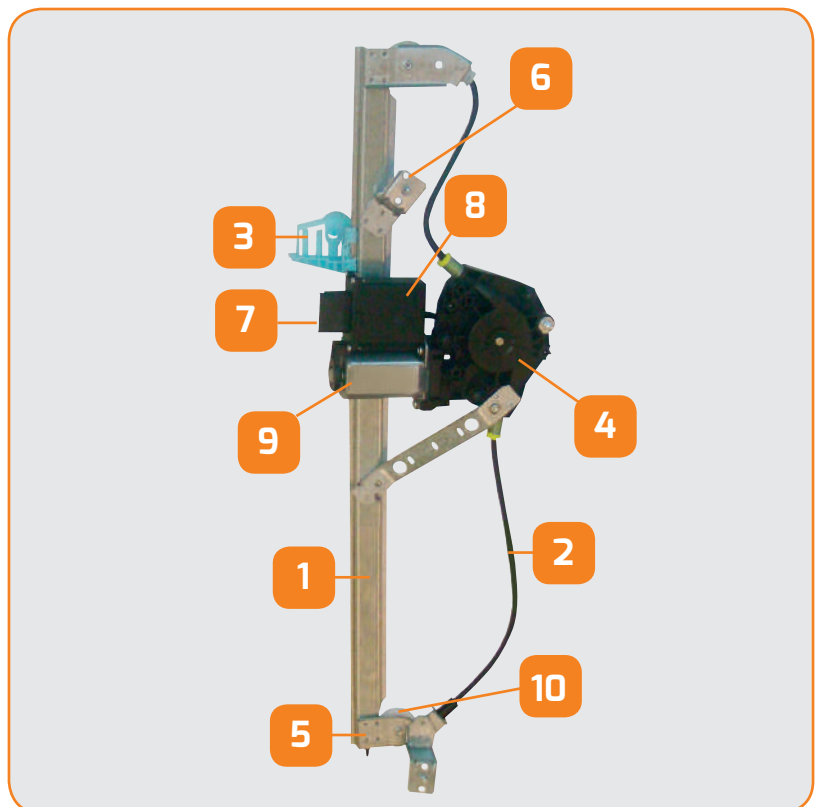

ALZACRISTALLI WINDOW REGULATORS

BRACCI INCROCIATI | *SCISSORS SYSTEM*

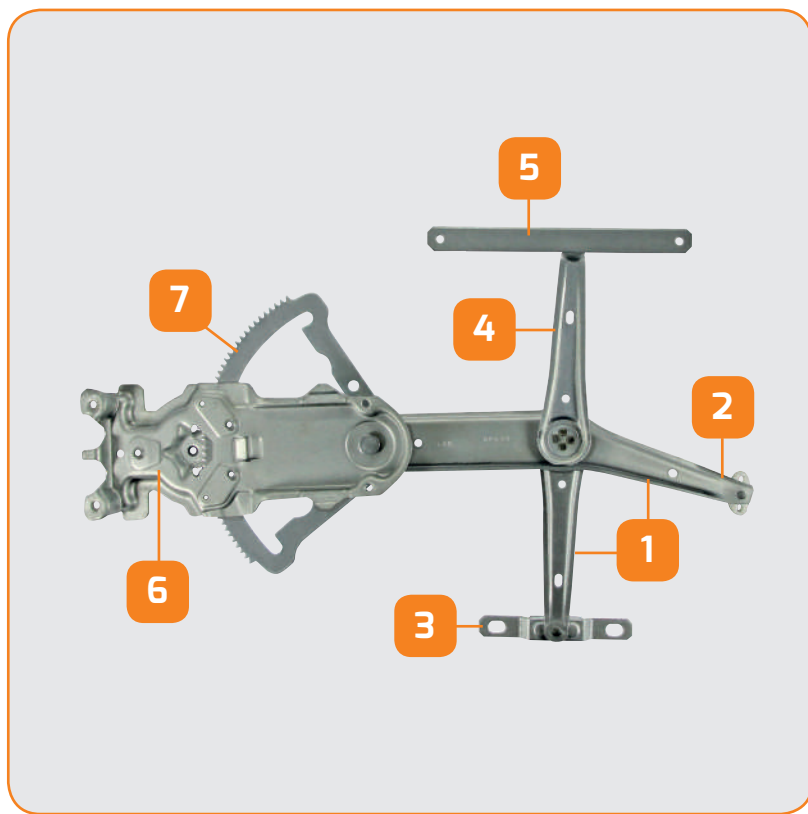

- BRACCIO SOLLEVAMENTO VETRO
GLASS LIFTING ARM 1
- SNODO ATTACCO GUIDA VETRO
GLASS RAIL BLOCK 2
- ATTACCO GUIDA VETRO
FIXATION BRACKET 3
- BRACCIO DI FISSAGGIO
FIXATION ARM 4
- GUIDA DI REGOLAZIONE
ADJUSTING RAIL 5
- PIASTRA DI FISSAGGIO
FIXATION PLATE 6
- CREMAGLIERA
RACK 7

FUNE GUIDATA | *BOWDEN TYPE* ALZACRISTALLO MANUALE | *MANUAL*

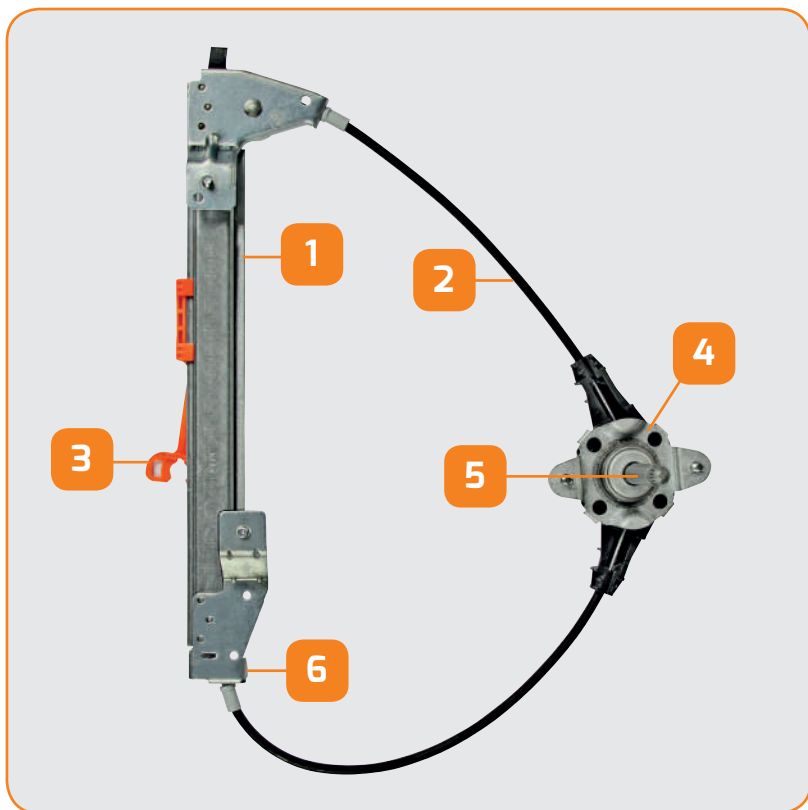

- GUIDA
RAIL 1
- FUNE
CABLE 2
- PATTINO / PIASTRA DI SOLLEVAMENTO
SLIDING GLASS FIXATION PLATE 3
- CARTELLA
CENTRAL FIXATION PLATE 4
- ALBERINO ATTACCO MANIGLIA
SHAFT 5
- STAFFA DI FISSAGGIO
FIXATION BRACKET 6

CAVO A SPIRALE | CABLE SYSTEM

- 1** GUIDA
RAIL
- 2** MOTORIDUTTORE
MOTOR
- 3** PATTINO / PIASTRA DI SOLLEVAMENTO
SLIDING GLASS FIXATION PLATE
- 4** GOMITO DI PLASTICA
PLASTIC ELBOW
- 5** TUBO
PLASTIC TUBE
- 6** STAFFA DI FISSAGGIO
FIXATION BRACKET

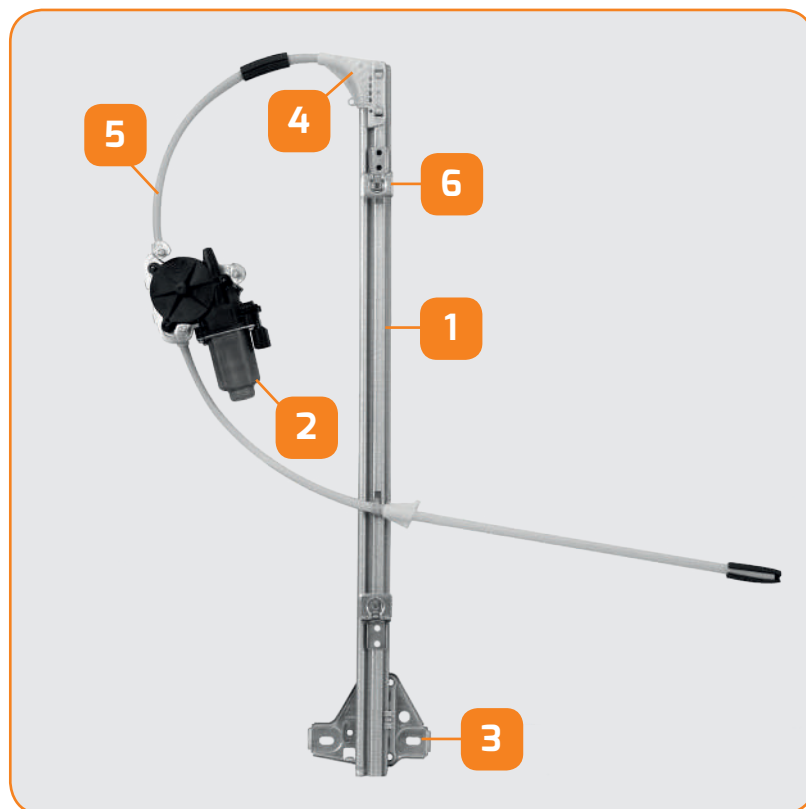

PANNELLO | PANEL

- 1** GUIDA
RAIL
- 2** FUNE
CABLE
- 3** PATTINO / PIASTRA DI SOLLEVAMENTO
SLIDING GLASS FIXATION PLATE
- 4** CARTELLA FISSAGGIO MOTORIDUTTORE
MOTOR FIXATION PLATE
- 5** CARRUCOLA
ROLLER
- 6** STAFFA DI FISSAGGIO
FIXATION BRACKET
- 7** PANNELLO
PANEL

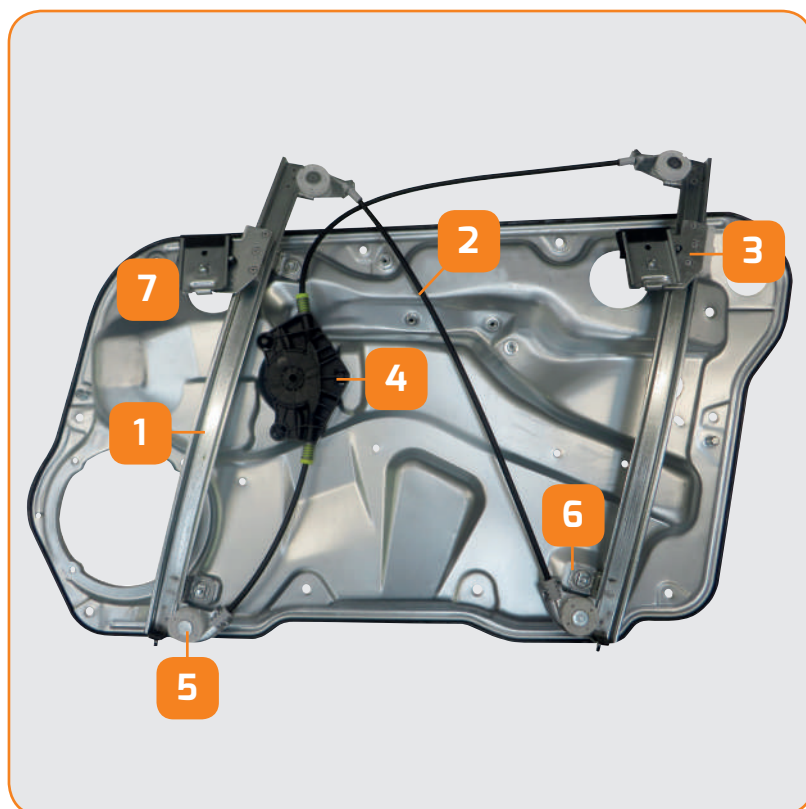

SOLO MOTORE SENZA FUNZIONE COMFORT | ONLY MOTOR WITHOUT COMFORT FUNCTION



SOLO MOTORE CON FUNZIONE COMFORT | ONLY MOTOR WITH COMFORT FUNCTION

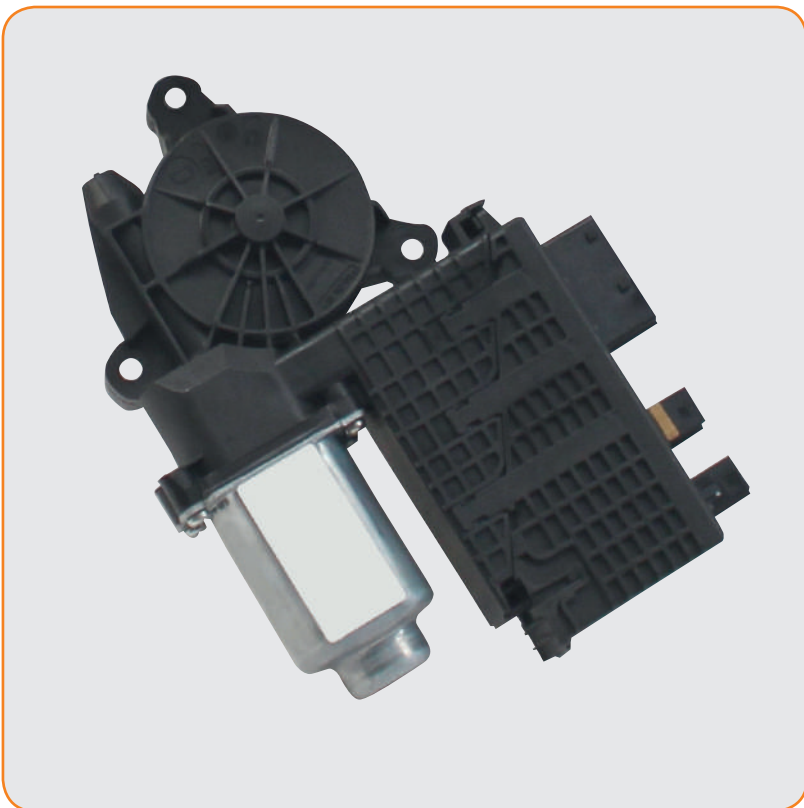

PORTE | NUMBERS OF DOORS | TÜREN | PORTES | PUERTAS



- 2 PORTE
- 2 DOORS
- 2-TÜRER
- 2 PORTES
- 2 PUERTAS



- 4 PORTE
- 4 DOORS
- 4-TÜRER
- 4 PORTES
- 4 PUERTAS



- 2 E 4 PORTE
- 2 AND 4 DOORS
- 2- UND 4-TÜRER
- 2 ET 4 PORTES
- 2 Y 4 PUERTAS

LATO SINISTRO | LEFT HAND SIDE | LINKE SEITE | COTE GAUCHE | LADO IZQUIERDO



- 2 PORTE ANTERIORI
- 2 DOORS FRONT
- 2-TÜRER VORNE
- 2 PORTES AVANT
- 2 PUERTAS DELANTERO



- 4 PORTE ANTERIORI
- 4 DOORS FRONT
- 4-TÜRER VORNE
- 4 PORTES AVANT
- 4 PUERTAS DELANTERO



- 4 PORTE POSTERIORI
- 4 DOORS REAR
- 4-TÜRER HINTEN
- 4 PORTES ARRIERE
- 4 PUERTAS TRASERO

LATO DESTRO | RIGHT HAND SIDE | RECHTE SEITE | COTE DROIT | LADO DERECHO



- 2 PORTE ANTERIORI
- 2 DOORS FRONT
- 2-TÜRER VORNE
- 2 PORTES AVANT
- 2 PUERTAS DELANTERO



- 4 PORTE ANTERIORI
- 4 DOORS FRONT
- 4-TÜRER VORNE
- 4 PORTES AVANT
- 4 PUERTAS DELANTERO



- 4 PORTE POSTERIORI
- 4 DOORS REAR
- 4-TÜRER HINTEN
- 4 PORTES ARRIERE
- 4 PUERTAS DELANTERO



- LUNOTTO POSTERIORE
- REAR WINDOW
- HECKSCHEIBE
- LUNETTE ARRIERE
- LUNETAS TRASERA



- SOLO MOTORE CON FUNZIONE COMFORT
- MOTOR ONLY WITH COMFORT FUNCTION
- NUR MOTOR MIT KOMFORT-FUNKTION
- MOTEUR AVEC FONCTION CONFORT UNIQUEMENT
- SOLO MOTOR CON FUNCION CONFORT



- NON COMPATIBILE CON FUNZIONE COMFORT
- NOT COMPATIBLE WITH COMFORT FUNCTION
- NICHT KOMPATIBEL MIT KOMFORT-FUNKTION
- NON COMPATIBLE AVEC FONCTION CONFORT
- SIN FUNCION CONFORT

- SOLO MOTORE SENZA FUNZIONE COMFORT
- MOTOR ONLY WITHOUT COMFORT FUNCTION
- NUR MOTOR OHNE KOMFORT-FUNKTION
- MOTEUR SANS FONCTION CONFORT UNIQUEMENT
- SOLO MOTOR SIN FUNCION CONFORT

SIMBOLI SYMBOLS

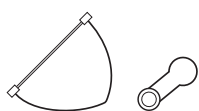

- ALZACRISTALLO MANUALE
- *MANUAL WINDOW REGULATOR*
- MANUELLER FENSTERHEBER
- LEVE-VITRE MANUEL
- ELEVELUNAS MANUAL

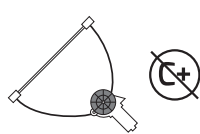

- ALZACRISTALLO CON MOTORE 2 PIN
- *ELECTRIC WINDOW REGULATOR WITHOUT COMFORT FUNCTION*
- FENSTERHEBER MIT 2 POLIGEM MOTOR
- *LEVE-VITRE AVEC MOTEUR 2 PINS*
- ELEVELUNAS CON MOTOR CON 2 PINES

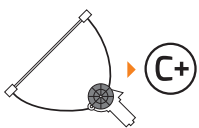

- ALZACRISTALLO CON MOTORE COMFORT
- *ELECTRIC WINDOW REGULATOR WITH COMFORT FUNCTION*
- FENSTERHEBER MIT KOMFORT-MOTOR
- *LEVE-VITRE AVEC MOTEUR COMFORT*
- ELEVELUNAS CON MOTOR COMFORT

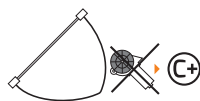

- SOLO MECCANISMO PER MOTORI CON FUNZIONE COMFORT
- *MECHANISM ONLY FOR COMFORT FUNCTION MOTOR*
- NUR MECHANISMUS FÜR MOTOR MIT KOMFORTFUNKTION
- *MECANISME POUR CONFORT MOTEUR UNIQUEMENT*
- SOLO MECANISMO PARA MOTOR COMFORT

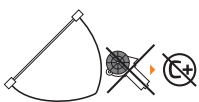

- SOLO MECCANISMO PER MOTORI 2 PIN
- *MECHANISM ONLY FOR MOTOR WITHOUT COMFORT FUNCTION*
- NUR MECHANISMUS FÜR 2 POLIGEN MOTOR
- *MECANISME POUR MOTEUR AVEC 2 PINS UNIQUEMENT*
- SOLO MECANISMO PARA MOTOR 2 PINES

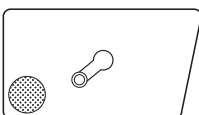

- PANNELLO CON MECCANISMO PER SISTEMA MANUALE
- *PANEL WITH MECHANISM FOR MANUAL WINDOW REGULATOR*
- RÜCKENPLATTE MIT MECHANISMUS FÜR MANUELLES SYSTEM
- *PANNEAU AVEC MECANISME POUR SYSTEME MANUEL*
- PANEL CON MECANISMO PARA SISTEMA MANUAL

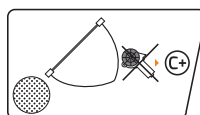

- PANNELLO CON MECCANISMO PER MOTORI CON FUNZIONE COMFORT
- *PANEL WITH MECHANISM ONLY FOR COMFORT FUNCTION MOTOR*
- RÜCKENPLATTE MIT MECHANISMUS FÜR MOTOR MIT KOMFORTFUNKTION
- *PANNEAU AVEC MECANISME POUR MOTEUR AVEC FONCTION COMFORT*
- PANEL CON MECANISMO PARA MOTOR CON FUNCION COMFORT

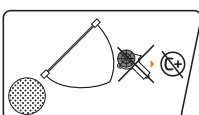

- PANNELLO CON MECCANISMO PER MOTORE 2 PIN
- *PANEL WITH MECHANISM ONLY FOR MOTOR WITHOUT COMFORT FUNCTION*
- RÜCKENPLATTE MIT MECHANISMUS FÜR 2 POLIGEN MOTOR
- *PANNEAU AVEC MECANISME POUR MOTEUR 2 PINS*
- PANEL CON MECANISMO PARA MOTOR CON 2 PINES

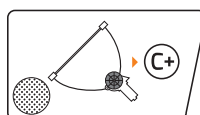

- PANNELLO CON SISTEMA COMFORT
- *PANEL WITH ELECTRIC WINDOW REGULATOR WITH COMFORT FUNCTION*
- RÜCKENPLATTE MIT KOMFORTSYSTEM
- *PANNEAU AVEC SYSTEME COMFORT*
- PANEL CON SISTEMA COMFORT

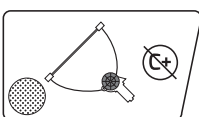

- PANNELLO CON SISTEMA 2 PIN
- *PANEL WITH ELECTRIC WINDOW REGULATOR WITHOUT COMFORT FUNCTION*
- RÜCKENPLATTE MIT 2-POL-SYSTEM
- *PANNEAU AVEC SYSTEME 2 PINS*
- PANEL CON SISTEMA 2 PINES













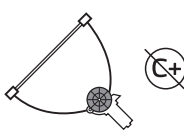



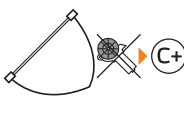



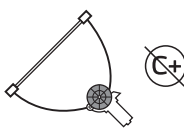



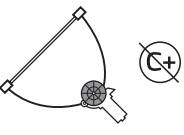



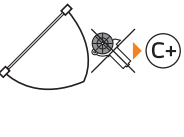

- INQUADRA IL QR CODE PER SCARICARE LE ISTRUZIONI DI MONTAGGIO
- *SCAN THE QR CODE TO DOWNLOAD THE FITTING INSTRUCTION*
- ZUM HERUNTERLADEN DER MONTAGEANLEITUNG QR-CODE MIT SMARTPHONE EINLESEN
- *SCANNER LE CODE QR POUR TELECHARGER LES INSTRUCTIONS DE MONTAGE*
- ESCANEAR EL CÓDIGO QR PARA DESCARGAR LAS INSTRUCCIONES DE MONTAJE

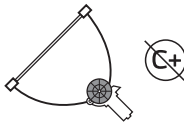



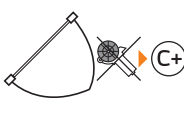





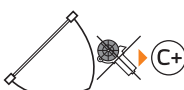





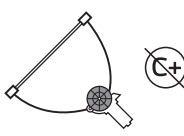





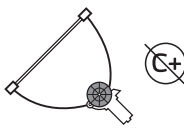



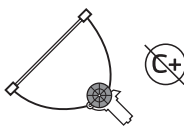



- ALZACRISTALLI
- WINDOW REGULATORS
- FENSTERHEBER
- LEVE-VITRES
- ELEVACIONES

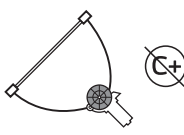



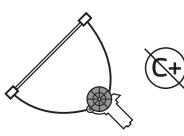





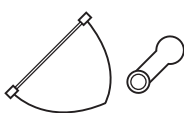



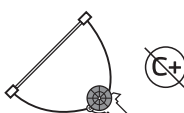



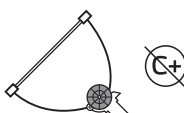



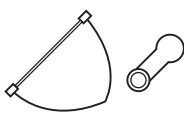



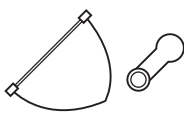



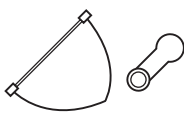



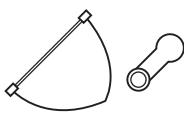



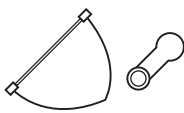



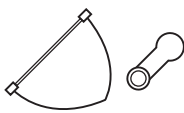



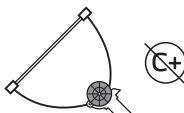



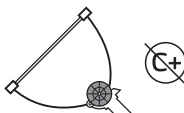





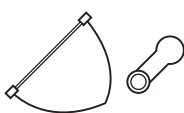



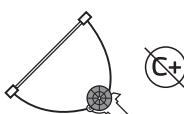





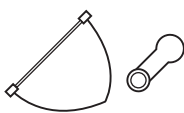



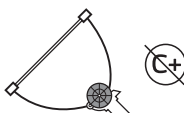





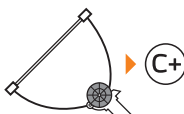



Daf	3
Isuzu	5
Iveco	6
Man	14
Mercedes Benz Trucks	15
Renault Trucks	17
Scania	20
Volvo Trucks	21

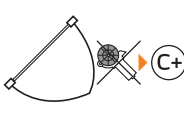



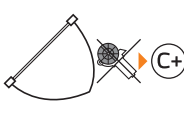





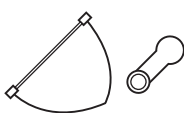



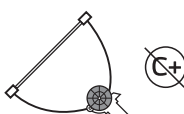



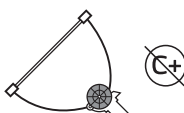



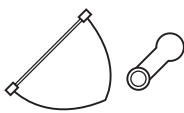



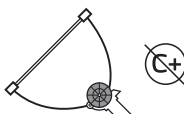

Modello Model	Porte Doors	Ns. Rif. Our RIF	Tecnologia Technology	Connettore Connector	OEM	
CF SERIE						
2001>		BI 11232 L				
		BI 11232 R				
2001>		BI 11314 L				
		BI 11314 R				
2001>		BI 11252 L				
		BI 11252 R				
1997>2002		BI 11294 L				
		BI 11294 R				
1997>2002		BI 11304 L				
		BI 11304 R				
1997>		BI 11294 L				
		BI 11294 R				
1997>		BI 11304 L				
		BI 11304 R				

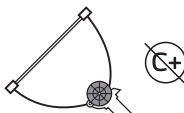



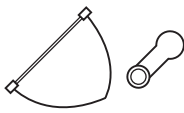





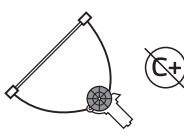



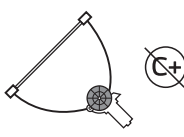



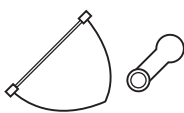



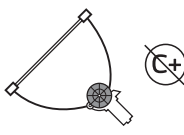

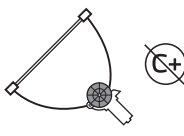

Modello Model	Porte Doors	Ns. Rif. Our Rif	Tecnologia Technology	Connettore Connector	OEM	
XF106						
2013>		BI 11742 L				
		BI 11742 R				
					1881915	



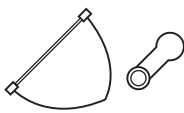



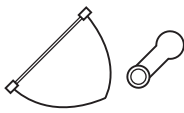



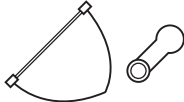



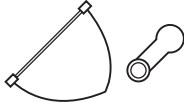







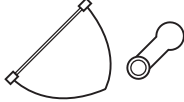

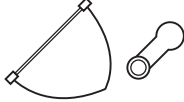

Modello Model	Porte Doors	Ns. Rif. Our Rif	Tecnologia Technology	Connettore Connector	OEM		
Amigo							
1991>		BI 60100 L				8970935320 8971658820	
		BI 60100 R					
F series							
1998>		BI 32074 L					
		BI 32074 R					
N series							
1998>		BI 32074 L					
		BI 32074 R					
NPR / NKR							
1998>2008		BI 32064 L				8978681142	
		BI 32064 R				8978681132	
NQR							
1998>2008		BI 32064 L				8978681142	
		BI 32064 R				8978681132	



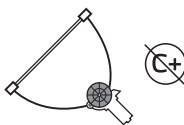



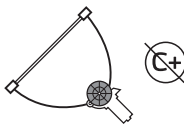





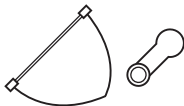



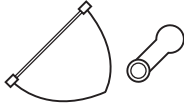



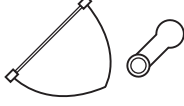









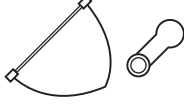

Modello Model	Porte Doors	Ns. Rif. Our Rif	Tecnologia Technology	Connettore Connector	OEM	
ASTRA HD7						
1996>2001		BI 11512 L				
		BI 11512 R				
1996>2001		BI 11262 L				
		BI 11262 R				
2005>		BI 11272 L				
		BI 11272 R				
DAILY I						
1978>1989		BI 11322 L				
		BI 11322 R				
1978>1989		BI 11332 L				
		BI 11332 R				
1978>1989		BI 11332 L				
		BI 11332 R				
1978>1989		BI 11332 L				
		BI 11332 R				
DAILY II						
1989>1999		BI 11342 L				
		BI 11342 R				
1989>1999		BI 11342 R				
		BI 11001 L				
1989>1999		BI 11001 L				
		BI 11001 R				
1989>1999		BI 11001 L				
		BI 11001 R				











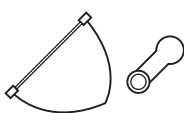



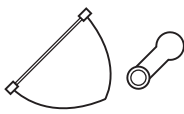



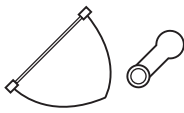



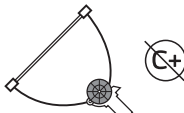







Modello Model	Porte Doors	Ns. Rif. Our RIF	Tecnologia Technology	Connettore Connector	OEM	
DAILY III - S2000						
1999>2006		BI 11472 L				
		BI 11472 R			500314250 504205271 5802133035	
1999>2006		BI 11052 L				
		BI 11052 R			500314230 504053528 504173866 9160793	
DAILY IV - V						
2006>2014		BI 11472 L				
		BI 11472 R			500314250 504205271 5802133035	
2006>2014		BI 11052 L				
		BI 11052 R			504053528 504173866 9160793	
2006>2014		BI 11702 L				
		BI 11702 R			504335517 42574133	
2006>2014		BI 11394 L				
		BI 11394 R			42565948 504356351 504335512	
2006>2014		BI 11404 L				
		BI 11404 R			5801482026	





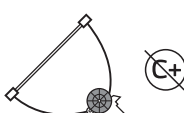





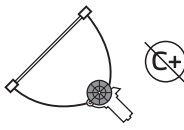





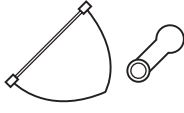



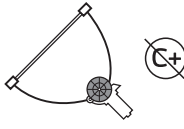





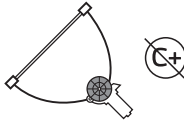



Modello Model	Porte Doors	Ns. Rif. Our Rif	Tecnologia Technology	Connettore Connector	OEM		
EuroCargo							
1991>2002		BI 11372 L				98407740 98407744	
		BI 11372 R					
1991>2002		BI 11015 L				98407722 99487781 2997196	
		BI 11015 R				98407721 99487780 2997195	
1991>2002		BI 11112 L				98407722 99487781 2997196	
		BI 11112 R				98407721 99487780 2997195	
EuroStar							
1992>2002		BI 11372 L				98407740 98407744	
		BI 11372 R				98407741 98407743	
1992>2002		BI 11015 L				98407722 99487781 2997196	
		BI 11015 R				98407721 99487780 2997195	
1992>2002		BI 11112 L				98407722 99487781 2997196	
		BI 11112 R				98407721 99487780 2997195	
EuroTech							
1991>2002		BI 11372 L				98407740 98407744	
		BI 11372 R				98407741 98407743	

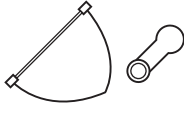



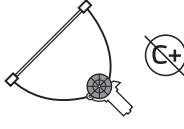





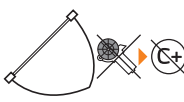



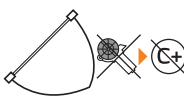







Modello Model	Porte Doors	Ns. Rif. Our RIF	Tecnologia Technology	Connettore Connector	OEM	
EuroTech						
1991>2002		BI 11015 L				
		BI 11015 R				
1991>2002		BI 11112 L				
		BI 11112 R				
Eurotrakker						
1993>2004		BI 11372 L				
		BI 11372 R				
1993>2004		BI 11015 L				
		BI 11015 R				
1993>2004		BI 11112 L				
		BI 11112 R				
GRINTA						
1975>1978		BI 11312			93901001	
1975>1978		BI 11312			93901001	











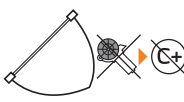



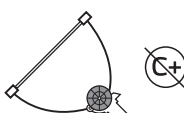

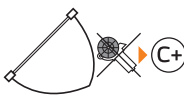





Modello Model	Porte Doors	Ns. Rif. Our Rif	Tecnologia Technology	Connettore Connector	OEM	
GRINTA						
1978>1981		BI 11322 L			93902695	
		BI 11322 R				
1981>1989		BI 11332 L			93908382 2997181	
		BI 11332 R			93908381 2997182	
1989>		BI 11342 L			93941271	
		BI 11342 R			93941270	
LEONCINO						
		BI 11402 L			9050668	
		BI 11402 R			9050667	
Magirus						
1991>		BI 11372 L			98407740 98407744	
		BI 11372 R			98407741 98407743	
1991>		BI 11015 L			98407722 99487781 2997196	
		BI 11015 R			98407721 99487780 2997195	
1991>		BI 11112 L			98407722 99487781 2997196	
		BI 11112 R			98407721 99487780 2997195	

Modello Model	Porte Doors	Ns. Rif. Our RIF	Tecnologia Technology	Connettore Connector	OEM		
OM 100 NC							
		BI 11412 L			4644623		
		BI 11412 R			4644622		
OM 110							
		BI 11412 L			4644623		
		BI 11412 R			4644622		
OM 190 NC							
		BI 11412 L			4644623		
		BI 11412 R			4644622		
OM 300							
		BI 11412 L			4644623		
		BI 11412 R			4644622		
OM 619							
		BI 11412 L			4644623		
		BI 11412 R			4644622		
OM 684							
		BI 11412 L			4644623		
		BI 11412 R			4644622		
OM 691							
		BI 11412 L			4644623		
		BI 11412 R			4644622		

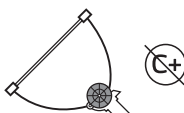
Modello Model	Porte Doors	Ns. Rif. Our Rif	Tecnologia Technology	Connettore Connector	OEM	
OM 697						
		BI 11412 L			4644623	
		BI 11412 R			4644622	
S SERIE						
1981>1989		BI 11332 L			93908382 2997181	
					BI 11332 R	
1989>		BI 11342 L			93941271	
					BI 11342 R	
1989>		BI 11001 L			4856064 99485358	
					BI 11001 R	
SERIE Z						
		BI 11422 L			9052882	
		BI 11422 R			9052881	
STRALIS						
2002>2013		BI 11372 L			98407740 98407744	
					BI 11372 R	
2002>2013		BI 11015 L			98407722 99487781 2997196	
					BI 11015 R	

Modello Model	Porte Doors	Ns. Rif. Our RIF	Tecnologia Technology	Connettore Connector	OEM	
STRALIS						
2002>2013		BI 11112 L				
		BI 11112 R				
		BI 11112 R			98407721 99487780 2997195	
TIGROTTO						
		BI 11402 L			9050668	
		BI 11402 R			9050667	
		BI 11402 R				
Trakker						
2004>		BI 11015 L				
		BI 11015 R				
		BI 11015 R			98407721 99487780 2997195	
2004>		BI 11112 L				
		BI 11112 R				
		BI 11112 R			98407721 99487780 2997195	
TurboStar						
1988>		BI 11502 L			4817019	
		BI 11502 R			4817018	
		BI 11502 R				
1988>		BI 11004 L				
		BI 11004 R				
		BI 11004 R			4817201	

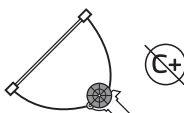







Modello Model	Porte Doors	Ns. Rif. Our Rif	Tecnologia Technology	Connettore Connector	OEM	
TGA						
2000>2007		BI 11592 L			81626456053	
		BI 11592 R			81626456052	
TGL						
2000>		BI 11592 L			81626456053	
		BI 11592 R			81626456052	
TGM						
2000>		BI 11592 L			81626456053	
		BI 11592 R			81626456052	
TGS						
2007>		BI 11242 L			81626456055	
		BI 11242 R			81626456054	
TGX						
2007>		BI 11242 L			81626456055	
		BI 11242 R			81626456054	



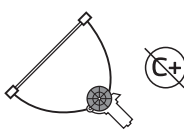







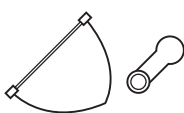



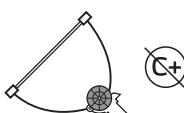



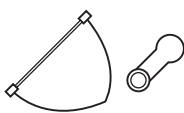



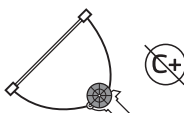



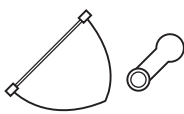

Modello Model	Porte Doors	Ns. Rif. Our RIF	Tecnologia Technology	Connettore Connector	OEM		
Actros MP1							
1996>2003		BI 11752 L			A0007250002 A0007200079		
		BI 11752 R					A0007250102 A0007200179
1996>2003		BI 11292 L			A0007250002 A0007200079		
		BI 11292 R					A0007250102 A0007200179
Actros MP2							
2003>2008		BI 11602 L			9607201346		
		BI 11602 R			9607201446		
2008>2012		BI 11602 L			9607201346		
		BI 11602 R			9607201446		
Actros MP4							
2012>		BI 11104 L			A9607201746		
		BI 11104 R			A9607201646		
Arocs							
1998>2011		BI 11202 L			A9737200346		
		BI 11202 R			A9737200446		
ATEGO							
1998>2003		BI 11202 L			A9737200346		
		BI 11202 R			A9737200446		

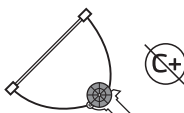



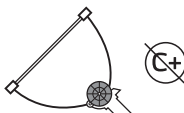





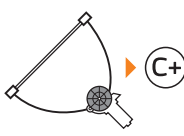





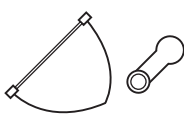



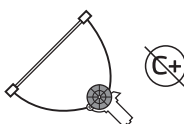





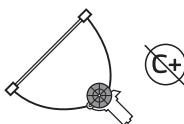





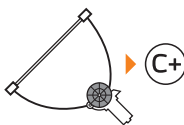



Mercedes Benz Trucks

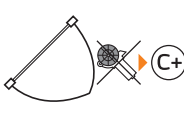



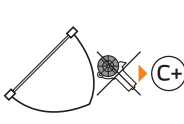





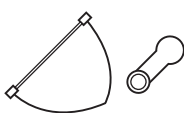



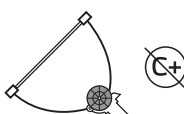









Alzacristalli | Window regulators





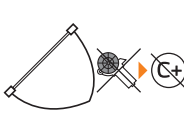





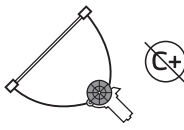



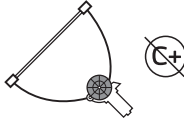











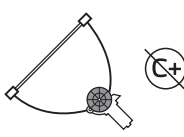





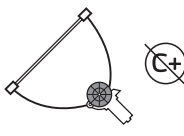





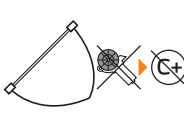





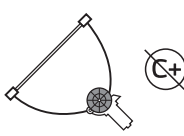



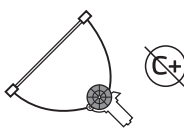

Modello Model	Porte Doors	Ns. Rif. Our Rif	Tecnologia Technology	Connettore Connector	OEM		
AXOR 98-03							
1998>2003	 	BI 11202 L				A9737200346	
	 	BI 11202 R				A9737200446	

Modello Model	Porte Doors	Ns. Rif. Our Rif	Tecnologia Technology	Connettore Connector	OEM		
C series 250-320CV							
2013>		BI 11462 L				7482497191	
		BI 11462 R					
2013>		BI 11252 L				7482497193 7484561609	
		BI 11252 R				7482497194 7484561621	
D series 10-18T; 18-26T							
2013>		BI 11462 L				7482497191	
		BI 11462 R					
2013>		BI 11252 L				7482497193	
		BI 11252 R					
Kerax							
>2012		BI 11462 L				5010301991	
		BI 11462 R					
>2012		BI 11252 L				5010301993	
		BI 11252 R					
Magnum							
2000>2012		BI 11282				5010468940	
		BI 11282					

Modello Model	Porte Doors	Ns. Rif. Our Rif	Tecnologia Technology		Connettore Connector	OEM	
Magnum							
2000>2012		BI 11384				7482059716	
		BI 11384				7482059716	
Mascott							
1998>2012		BI 11472 L				7700351293	
		BI 11472 R				7700351294	
1998>2012		BI 11052 L				7700352494 8200162708	
		BI 11052 R				7700352495 8200162710	
1998>2012		BI 11052 L				7700352494 8200162708	
		BI 11052 R				7700352495 8200162710	
1998>2012		BI 11702 L				8200467971	
		BI 11702 R				8200467967	
1998>2012		BI 11394 L				8200467971	
		BI 11394 R				8200467967	
Maxity							
2007>		BI 11354 L				807010T000	
		BI 11354 R				807000T000	

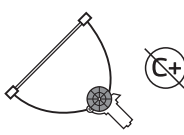
Modello Model	Porte Doors	Ns. Rif. Our Rif	Tecnologia Technology		Connettore Connector	OEM	
Midlum							
2000>		BI 11462 L				5010301991	
		BI 11462 R				5010301992	
2000>		BI 11252 L				5010301993	
		BI 11252 R				5010301994	
PREMIUM							
1996>2013		BI 11462 L				5010301991	
		BI 11462 R				5010301992	
1996>2013		BI 11252 L				5010301993	
		BI 11252 R				5010301994	
T series							
2015>		BI 11762 L				7482540378	
		BI 11762 R				7482540380	

Modello Model	Porte Doors	Ns. Rif. Our Rif	Tecnologia Technology		Connettore Connector	OEM	
3 SERIES							
1987>1996		BI 11212 L				1406613	
		BI 11212 R				1406614	
4 SERIES							
1996>2007		BI 75004 L				1366849 1442294 2303349 2303350	
		BI 75004 R				1366850 1442295 2303352 2303355	
1996>2007		BI 75014 L				1366849 1442294 2303349	
		BI 75014 R				1366850 1442295 2303352	

Modello Model	Porte Doors	Ns. Rif. Our Rif	Tecnologia Technology	Connettore Connector	OEM		
FE							
		BI 11252 L				20557552 82497193	
		BI 11252 R					
FH I							
1993>2013		BI 11222 L				3176541	
							
FH4							
2016>		BI 11772 L				84225944	
							
FL II							
2006>		BI 11252 L				20557552 82497193	
							
FM							
2005>2013		BI 11222 L				3176541	
							
FMX series							
2005>2013		BI 11222 L				3176541	
							



PMM

- GUIDA RAPIDA
- QUICK LIST



GUIDA RAPIDA / QUICK LIST

Alzacristalli / Window regulators



Ns. rif. Our ref.	Pagina Page	Ns. rif. Our ref.	Pagina Page	Ns. rif. Our ref.	Pagina Page
BI 11001 L	6, 12	BI 11412 L	11, 12		
BI 11001 R	6, 12	BI 11412 R	11, 12		
BI 11004 L	13	BI 11422 L	12		
BI 11004 R	13	BI 11422 R	12		
BI 11015 L	8, 9, 10, 12, 13	BI 11462 L	17, 19		
BI 11015 R	8, 9, 10, 12, 13	BI 11462 R	17, 19		
BI 11052 L	7, 18	BI 11472 L	7, 18		
BI 11052 R	7, 18	BI 11472 R	7, 18		
BI 11104 L	15	BI 11502 L	13		
BI 11104 R	15	BI 11502 R	13		
BI 11112 L	8, 9, 10, 13	BI 11512 L	6		
BI 11112 R	8, 9, 10, 13	BI 11512 R	6		
BI 11202 L	15, 16	BI 11592 L	14		
BI 11202 R	15, 16	BI 11592 R	14		
BI 11212 L	20	BI 11602 L	15		
BI 11212 R	20	BI 11602 R	15		
BI 11222 L	21	BI 11702 L	7, 18		
BI 11222 R	21	BI 11702 R	7, 18		
BI 11232 L	3	BI 11742 L	3		
BI 11232 R	3	BI 11742 R	3		
BI 11242 L	14	BI 11752 L	15		
BI 11242 R	14	BI 11752 R	15		
BI 11252 L	3, 17, 19, 21	BI 11762 L	19		
BI 11252 R	3, 17, 19, 21	BI 11762 R	19		
BI 11262 L	6	BI 11772 L	21		
BI 11262 R	6	BI 11772 R	21		
BI 11272 L	6	BI 32064 L	5		
BI 11272 R	6	BI 32064 R	5		
BI 11292 L	15	BI 32074 L	5		
BI 11292 R	15	BI 32074 R	5		
BI 11294 L	3, 4	BI 60100 L	5		
BI 11294 R	3, 4	BI 60100 R	5		
BI 11304 L	3, 4	BI 75004 L	20		
BI 11304 R	3, 4	BI 75004 R	20		
BI 11314 L	3	BI 75014 L	20		
BI 11314 R	3	BI 75014 R	20		
BI 11322 L	6, 10				
BI 11322 R	6, 10				
BI 11332 L	6, 10, 12				
BI 11332 R	6, 10, 12				
BI 11342 L	6, 10, 12				
BI 11342 R	6, 10, 12				
BI 11354 L	18				
BI 11354 R	18				
BI 11372 L	8, 9, 10, 12				
BI 11372 R	8, 9, 10, 12				
BI 11394 L	7, 18				
BI 11394 R	7, 18				
BI 11402 L	10, 13				
BI 11402 R	10, 13				
BI 11404 L	7				
BI 11404 R	7				



PMM

- TAVOLE DI COMPARAZIONE
- CROSS REFERENCE GUIDE



TAVOLE DI COMPARAZIONE / CROSS REFERENCE GUIDE

Alzacristalli / Window regulators



Rif. adattabilità Compatible OEM ref.	Ns. rif. Our ref.	Rif. adattabilità Compatible OEM ref.	Ns. rif. Our ref.	Rif. adattabilità Compatible OEM ref.	Ns. rif. Our ref.
1354702	BI 11294 L	4817202	BI 11004 L	8970935310	BI 60100 R
1354703	BI 11294 R	4856063	BI 11001 R	8970935320	BI 60100 L
1366849	BI 75004 L	4856064	BI 11001 L	8971658810	BI 60100 R
1366849	BI 75014 L	500314229	BI 11052 L	8971658820	BI 60100 L
1366850	BI 75004 R	500314230	BI 11052 R	8978681132	BI 32064 R
1366850	BI 75014 R	500314249	BI 11472 L	8978681142	BI 32064 L
1374568	BI 11232 L	500314250	BI 11472 R	9050667	BI 11402 R
1374569	BI 11232 R	500411309	BI 11272 L	9050668	BI 11402 L
1400753	BI 11252 L	500411310	BI 11272 R	9052881	BI 11422 R
1400754	BI 11252 R	5010301991	BI 11462 L	9052882	BI 11422 L
1400755	BI 11252 L	5010301992	BI 11462 R	9160792	BI 11052 L
1400756	BI 11252 R	5010301993	BI 11252 L	9160793	BI 11052 R
1406613	BI 11212 L	5010301994	BI 11252 R	93901001	BI
1406614	BI 11212 R	5010468940	BI	93902694	BI 11322 R
1442294	BI 75004 L	504053527	BI 11052 L	93902695	BI 11322 L
1442294	BI 75014 L	504053528	BI 11052 R	93908381	BI 11332 R
1442295	BI 75004 R	504173866	BI 11052 R	93908382	BI 11332 L
1442295	BI 75014 R	504173868	BI 11052 L	93926734	BI 11342 R
1705698	BI 11252 L	504205269	BI 11472 L	93926735	BI 11342 L
1705699	BI 11252 R	504205271	BI 11472 R	93941270	BI 11342 R
1714809	BI 11252 L	504335512	BI 11394 R	93941271	BI 11342 L
1714810	BI 11252 R	504335515	BI 11394 L	9607201346	BI 11602 L
1779721	BI 11304 L	504335517	BI 11702 R	9607201446	BI 11602 R
1779722	BI 11304 R	504335520	BI 11702 L	98171178	BI 11512 R
1881914	BI 11742 L	504356351	BI 11394 R	98171179	BI 11512 L
1881915	BI 11742 R	504356352	BI 11394 L	98171181	BI 11262 R
1918143	BI 11314 L	5801482026	BI 11404 R	98171182	BI 11262 L
1918144	BI 11314 R	5801482033	BI 11404 L	98407721	BI 11015 R
1918145	BI 11304 L	5802133034	BI 11472 L	98407721	BI 11112 R
1918146	BI 11304 R	5802133035	BI 11472 R	98407722	BI 11015 L
20557552	BI 11252 L	7482059716	BI	98407722	BI 11112 L
20557554	BI 11252 R	7482497191	BI 11462 L	98407740	BI 11372 L
2303349	BI 75004 L	7482497192	BI 11462 R	98407741	BI 11372 R
2303349	BI 75014 L	7482497193	BI 11252 L	98407743	BI 11372 R
2303350	BI 75004 L	7482497194	BI 11252 R	98407744	BI 11372 L
2303352	BI 75004 R	7482540378	BI 11762 L	99485357	BI 11001 R
2303352	BI 75014 R	7482540380	BI 11762 R	99485358	BI 11001 L
2303355	BI 75004 R	7484561609	BI 11252 L	99487780	BI 11015 R
2997181	BI 11332 L	7484561621	BI 11252 R	99487780	BI 11112 R
2997182	BI 11332 R	7700351293	BI 11472 L	99487781	BI 11015 L
2997183	BI 11342 R	7700351294	BI 11472 R	99487781	BI 11112 L
2997184	BI 11342 L	7700352494	BI 11052 L	A0007200079	BI 11752 L
2997193	BI 11001 R	7700352495	BI 11052 R	A0007200079	BI 11292 L
2997194	BI 11001 L	807000T000	BI 11354 R	A0007200179	BI 11752 R
2997195	BI 11015 R	807010T000	BI 11354 L	A0007200179	BI 11292 R
2997195	BI 11112 R	81626456052	BI 11592 R	A0007250002	BI 11752 L
2997196	BI 11015 L	81626456053	BI 11592 L	A0007250002	BI 11292 L
2997196	BI 11112 L	81626456054	BI 11242 R	A0007250102	BI 11752 R
3176541	BI 11222 L	81626456055	BI 11242 L	A0007250102	BI 11292 R
3176542	BI 11222 R	8200162708	BI 11052 L	A9607201646	BI 11104 R
42565948	BI 11394 R	8200162710	BI 11052 R	A9607201746	BI 11104 L
42565949	BI 11394 L	8200467967	BI 11702 R	A9737200346	BI 11202 L
42574132	BI 11702 L	8200467967	BI 11394 R	A9737200446	BI 11202 R
42574133	BI 11702 R	8200467971	BI 11702 L		
4644622	BI 11412 R	8200467971	BI 11394 L		
4644623	BI 11412 L	82497193	BI 11252 L		
4817018	BI 11502 R	82497194	BI 11252 R		
4817019	BI 11502 L	84225944	BI 11772 L		
4817201	BI 11004 R	84225953	BI 11772 R		